

plastic and
pool products

oku®
Obermaier GmbH

OKU Holzpool EMOTION-FUN

Oval 6,57 x 4,57 m

Höhe 1,31 m

Art. Nr.: 800530

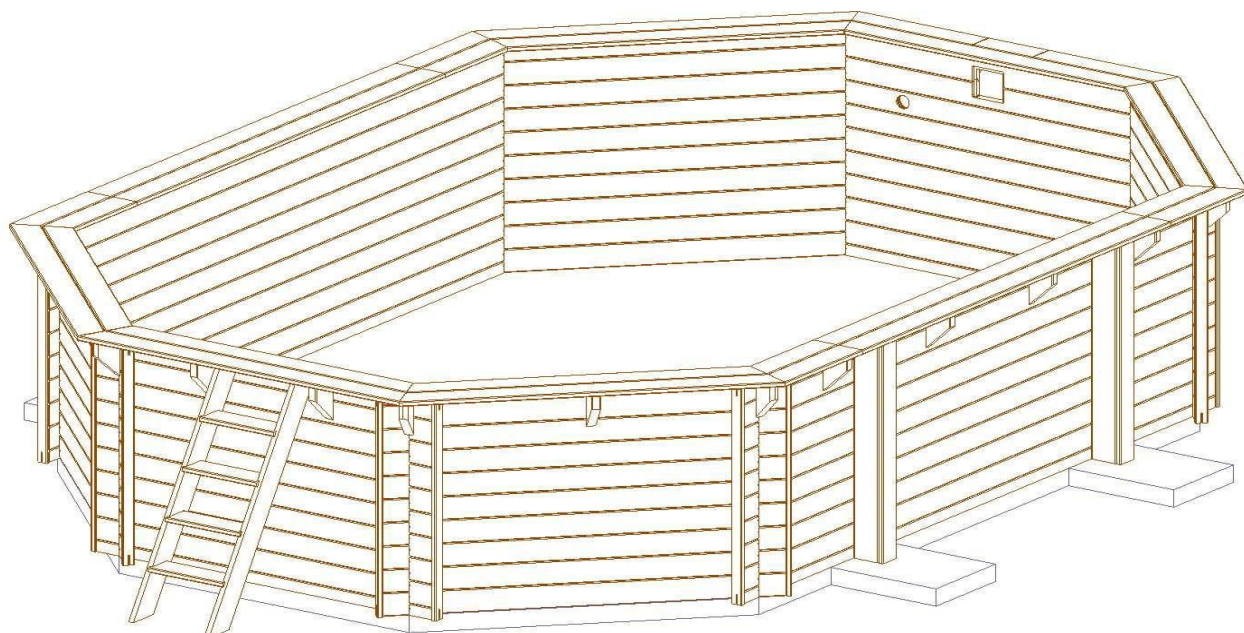
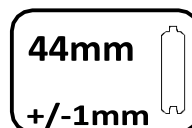



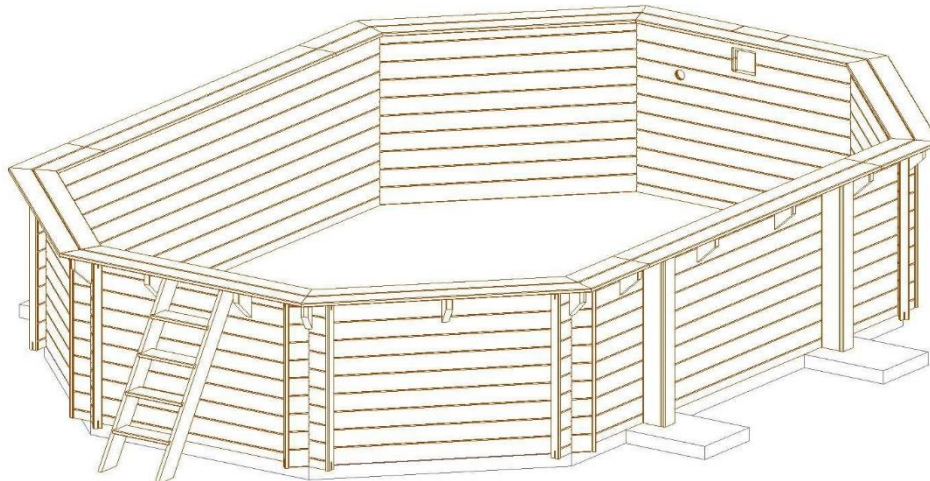
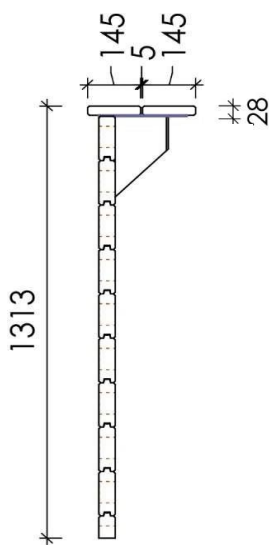
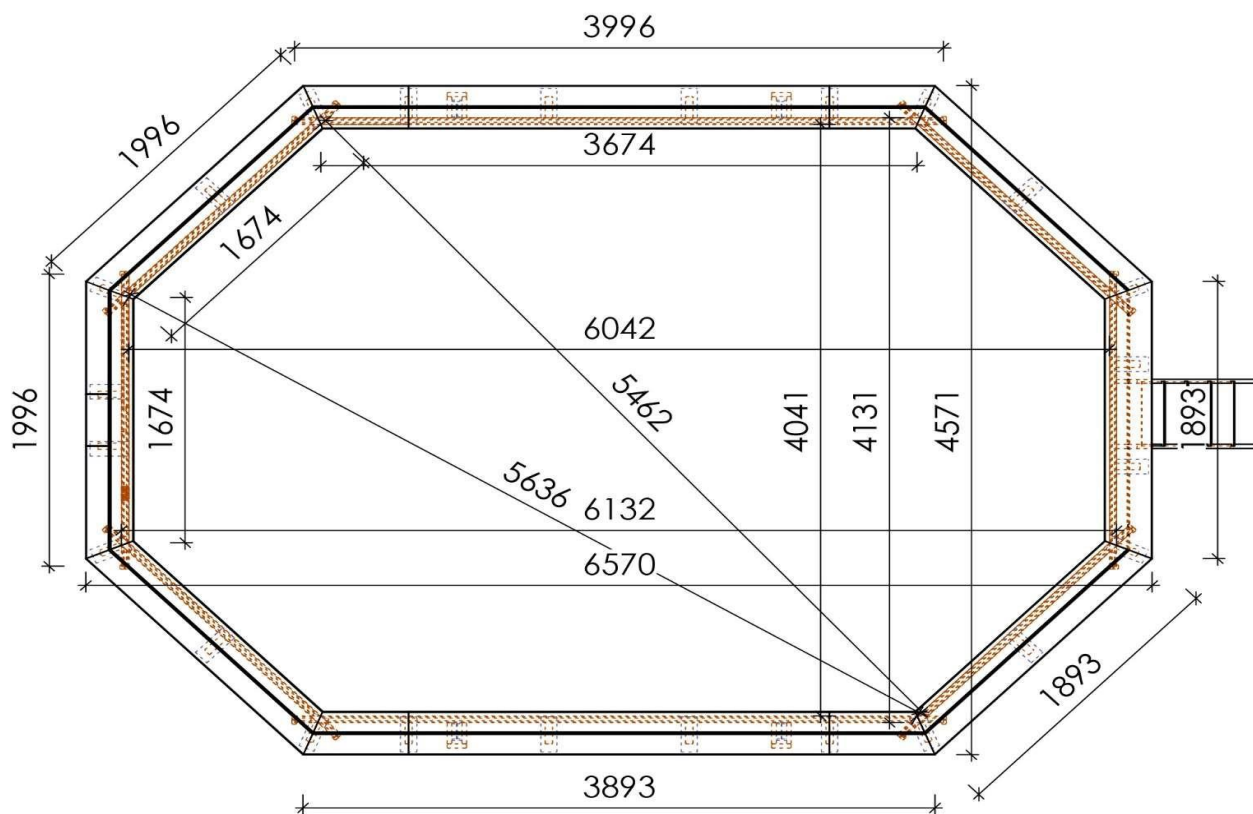
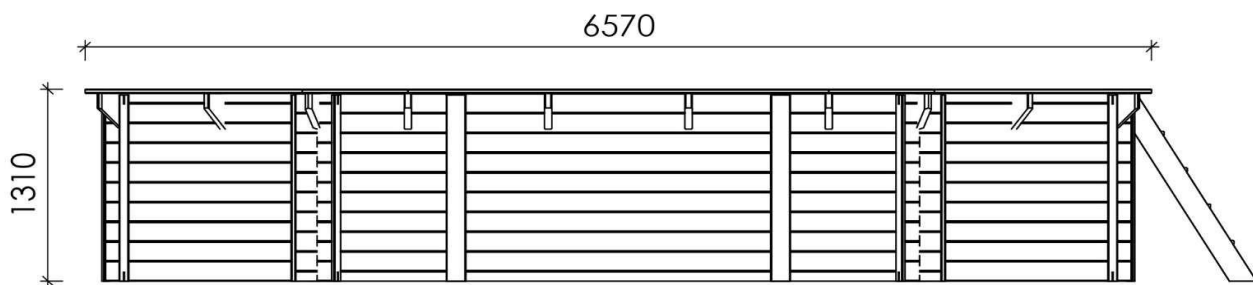





















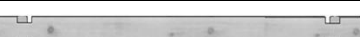











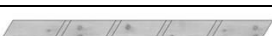





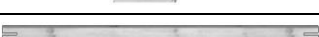
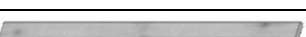

OKU Holzpool EMOTION-FUN Oval 6,57 x 4,57 Höhe 1,31 m Art. Nr.: 800530



OKU Holzpool EMOTION-FUN Oval 6,57 x 4,57 Höhe 1,31 m

Art. Nr. 800530

Nr	Artikel	Abmessung			Stück	A	B
		B	H	L			
1		28	145	2593	4		
2		28	145	650	2		
3		28	145	588	2		
4		28	145	650	2		
5		28	145	588	2		
6		28	145	1893	5		
7		28	145	1769	6		
8		28	145	767	2		
9		28	145	350	1		
10	 	45	145	3996	16		
11	 	45	135	3996	2		
12	 	45	78	3996	2		
13	 	45	145	1996	50		
14	 	45	135	1996	1		
15	 	45	78	1996	2		
16	 	45	67	1996	4		
17	 	45	135	1996	1		
18	 	45	145	1996	1		
19	 	45	145	1996	1		
20		28	145	1544	1		
21		28	145	1544	1		
22		28	145	440	4		
23	 	45	145	245	16		
24	 	45	145	245	8		
25		28	60	1270	16		
26		28	145	1270	8		
27		28	120	1270	4		
28		58	120	1700	4		
29		10	10	500	4		

Nr	Artikel	Abmessung	Stück	A	B
A		3,0x25	12		
B		3,5x25	300		
C		5x80	32		
D		4,5x60	84		
E		5x100	84		
F		3x100x240	24		
G			2		
H		40x40	2		

Werkzeug

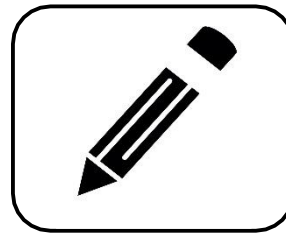
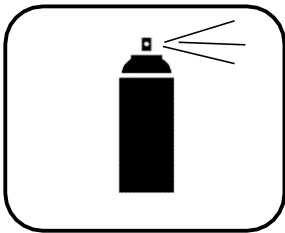
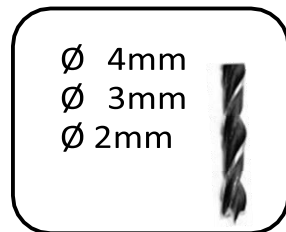
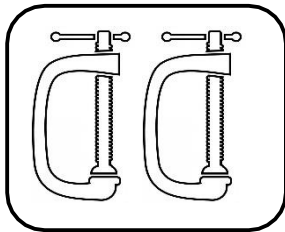
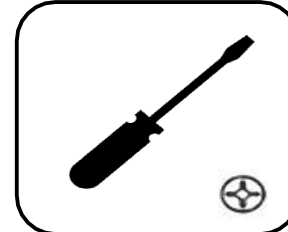
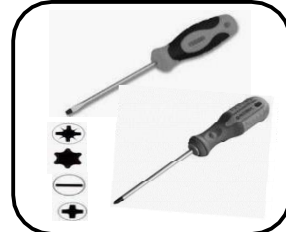
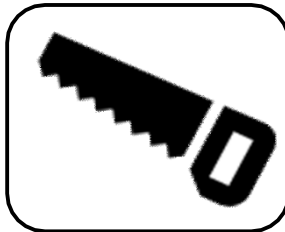
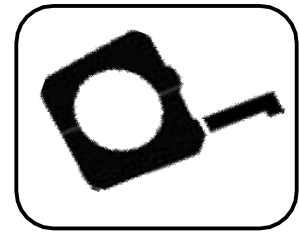
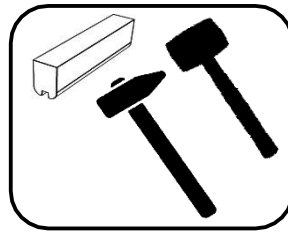
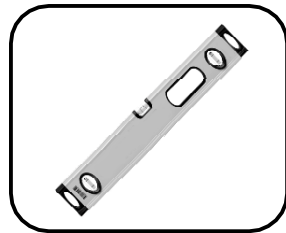
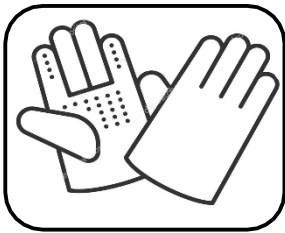

Wichtig!!!

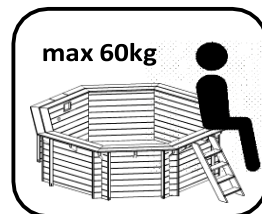
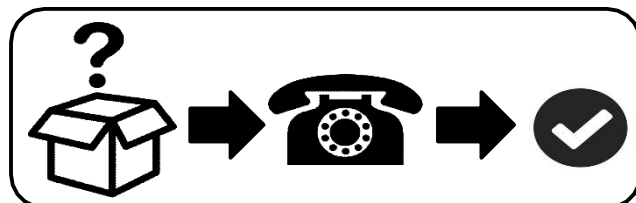
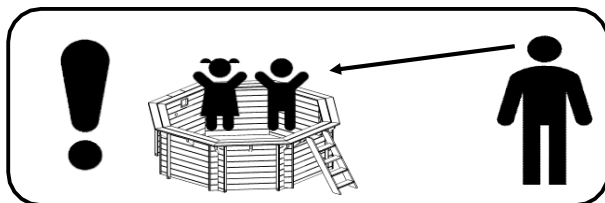
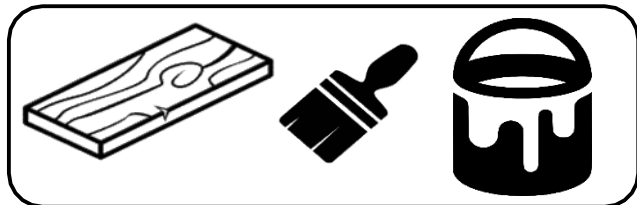
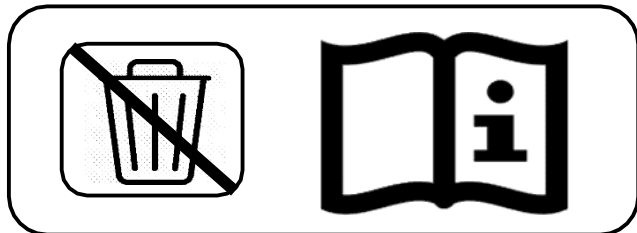
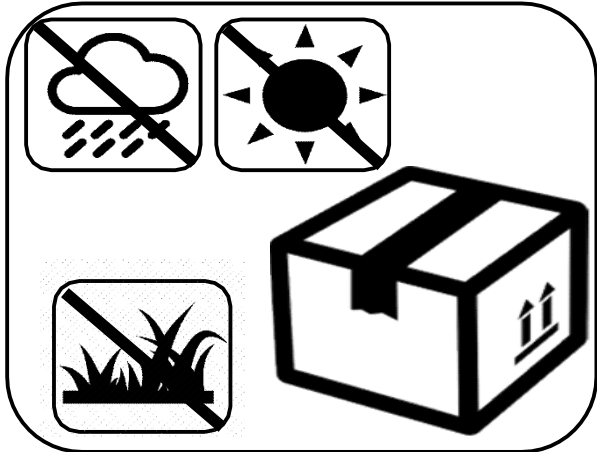
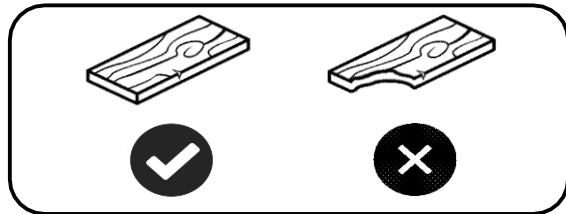
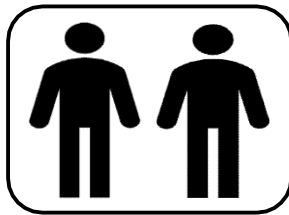

1. Der Holzpool sollte nicht unter oberirdischen Installationen wie Strom, Wasser und Gas installiert werden. Zudem sollte der Pool an einem Ort positioniert werden, welcher der Belastung des Pools standhält. Dafür **nicht** geeignet sind beispielsweise Balkone und Terrassen. Bei Missachtung dieser Vorgaben, kann es zu Schäden kommen.
2. Das Produkt sollte an einem Ort montiert werden, an dem es nicht in ständigem Kontakt mit Wasser ist (eingeschlossen der Sprinkleranlage).
3. Erkundigen Sie sich, bei der für Ihren Wohnsitz zuständigen Stelle, welche Bauvorschriften für das von Ihnen erworbene Produkt gelten.
4. Führen Sie die Fundamentarbeiten gemäß den Richtlinien dieses Handbuchs durch. Denken Sie daran, dass die Vorbereitung des Untergrunds entsprechend der Baupraxis erfolgen muss (Planen Sie die Zeit für die Trocknung des Betons mit ein).

Umgebung

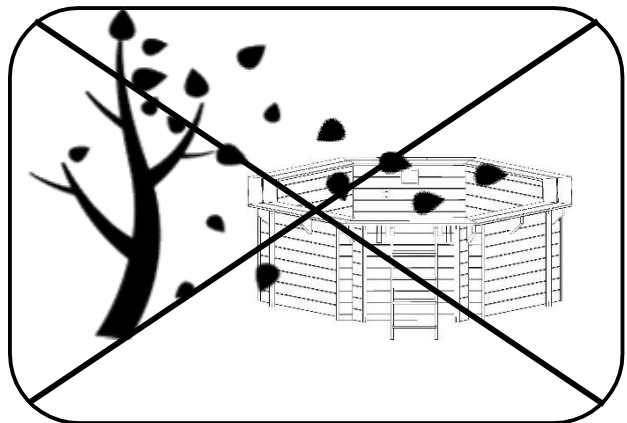
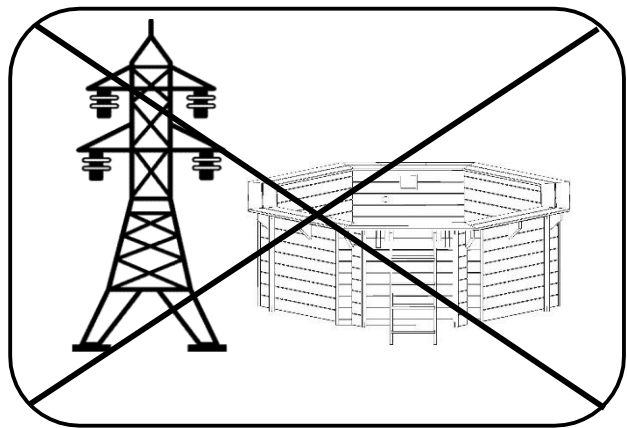
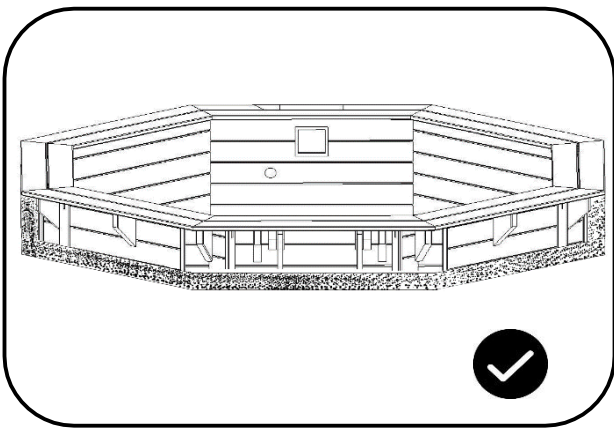
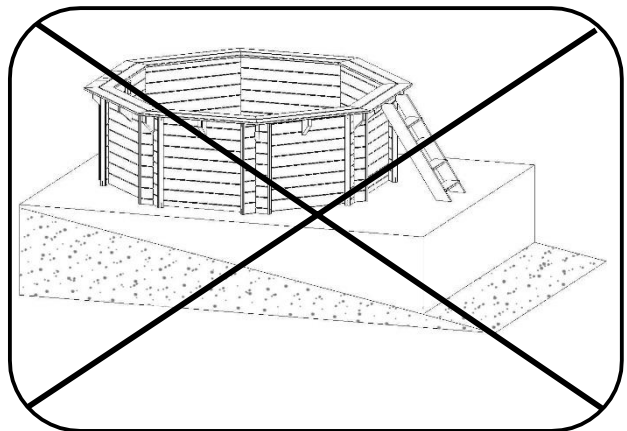
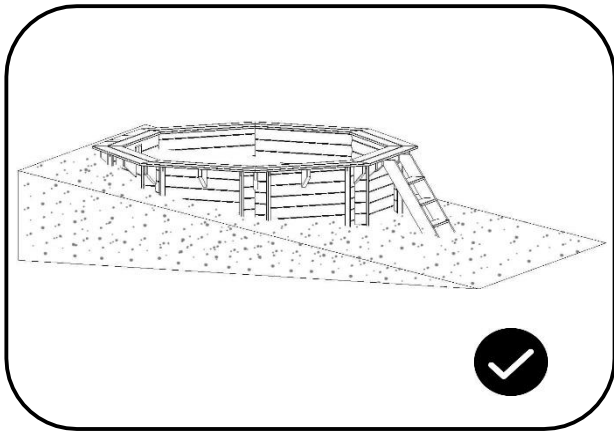
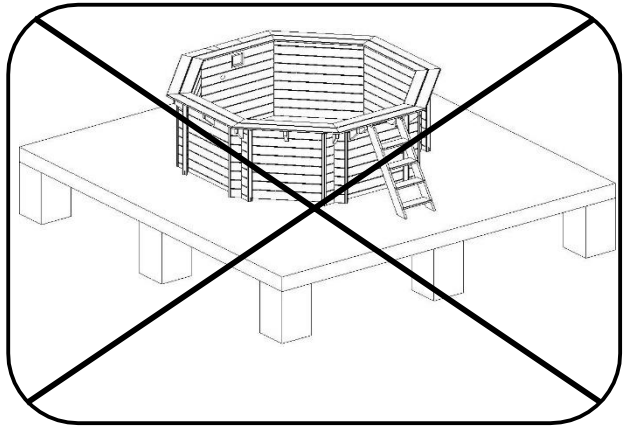
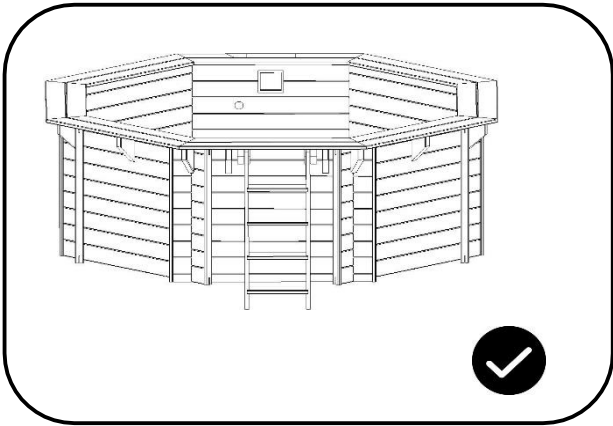

Positionierung der Poolwände:

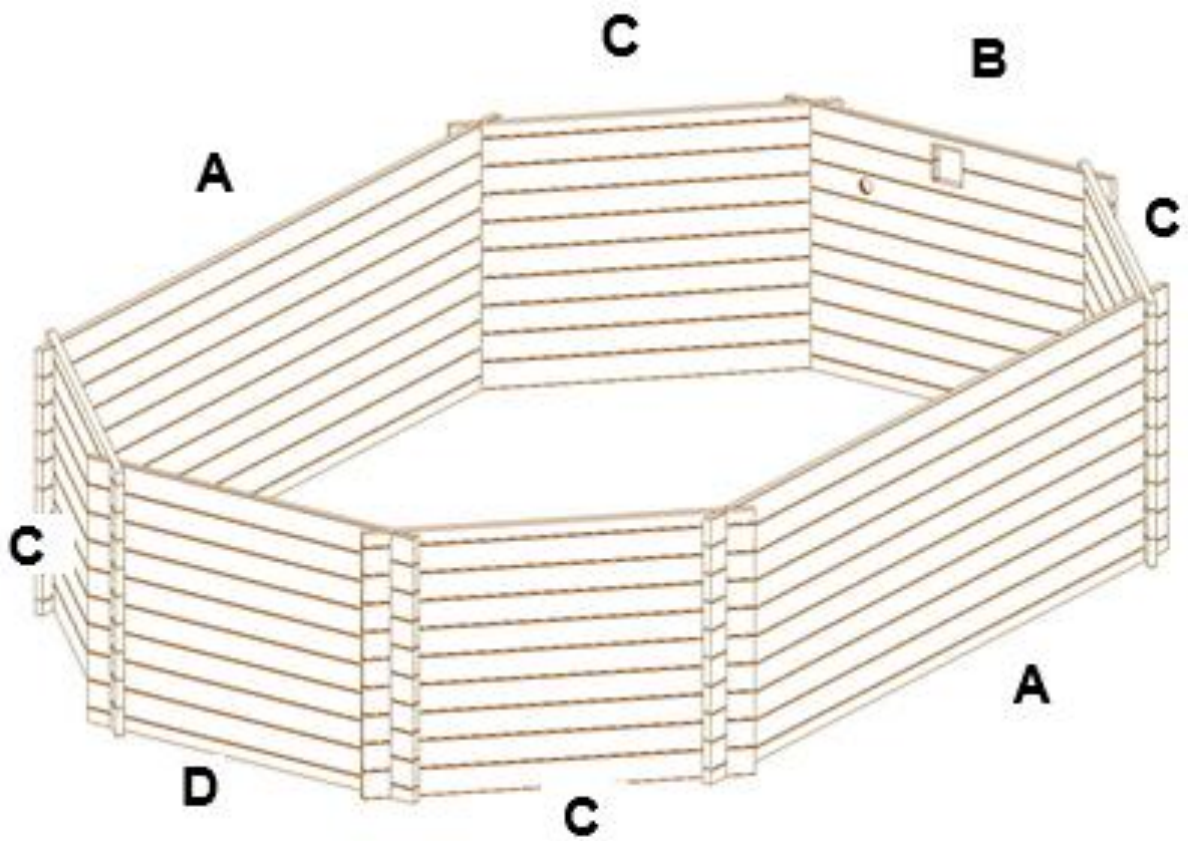

A x2



B

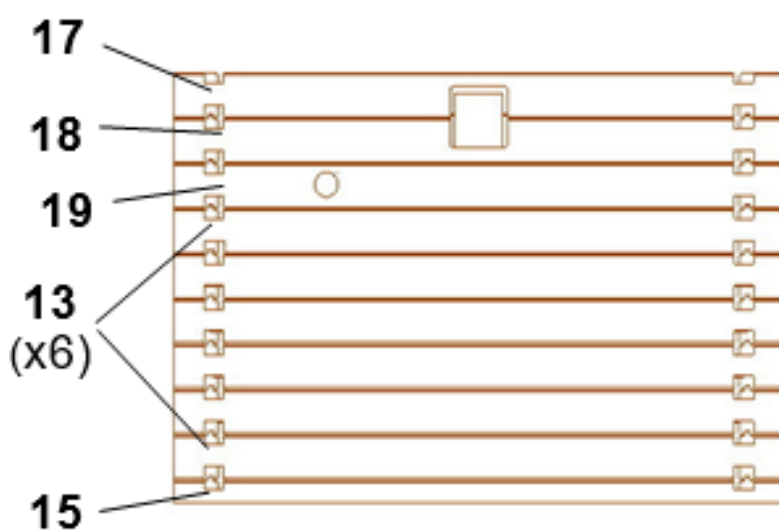

C x4

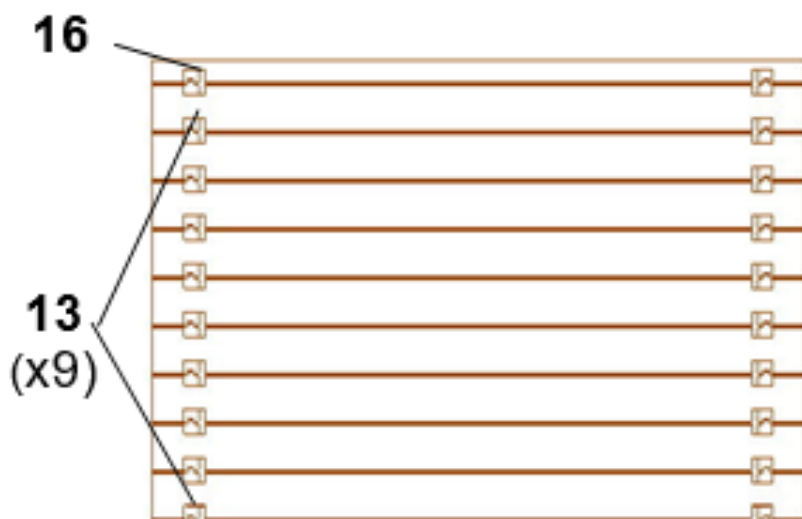

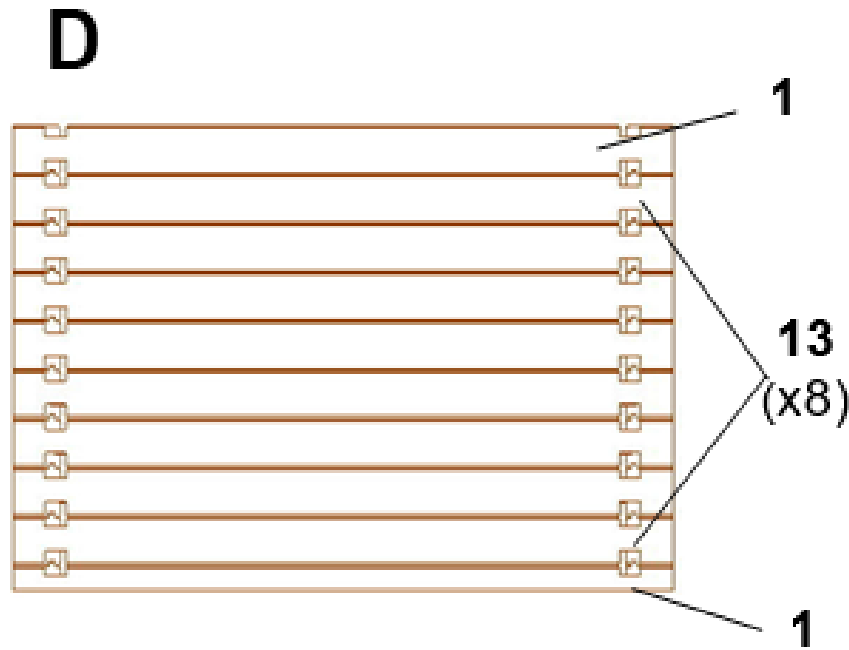

Betonfundament:

1. Der Standort für die Aufstellung des Schwimmbeckens muss mit Sorgfalt ausgewählt werden. Die Fläche muss eben, nivelliert und fest sein. Eine Betonplatte ist am besten geeignet, bei dieser die Betonklasse nicht weniger als C25 / 30, Expositionsklasse XC2 betragen darf.



2. Die Gesamtdicke der Betonplatte muss mindestens 10 cm betragen, wobei:
 - mindestens 5 cm über den Boden hinausragen muss - damit das Becken nicht im Wasser steht
 - mindestens 5 cm in den Boden eingelassen sein muss
3. Die Metallstützen müssen nach den im Handbuch angegebenen Richtlinien betoniert werden.
4. Die Betonplatte muss an die Topografie angepasst werden.
5. Die Vorbereitung des Standorts muss mit der exakten Festlegung der Abmessungen des Schwimmbeckens plus 10 cm mehr festgelegt werden. Sie sollten auch die Entfernung zu Strom und Wasser berücksichtigen. Es wird empfohlen, das Schwimmbecken an einem sonnigen Ort aufzustellen.

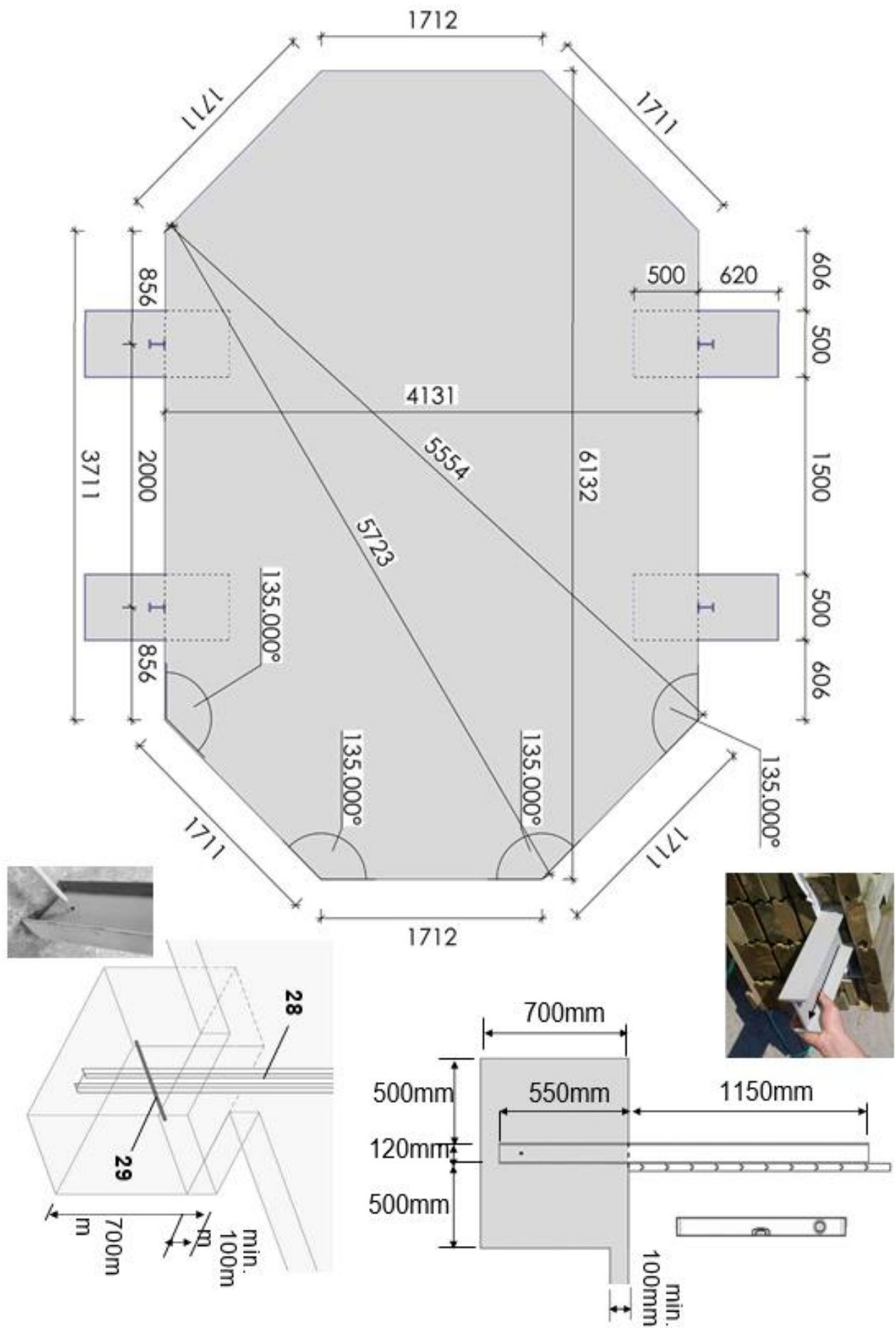

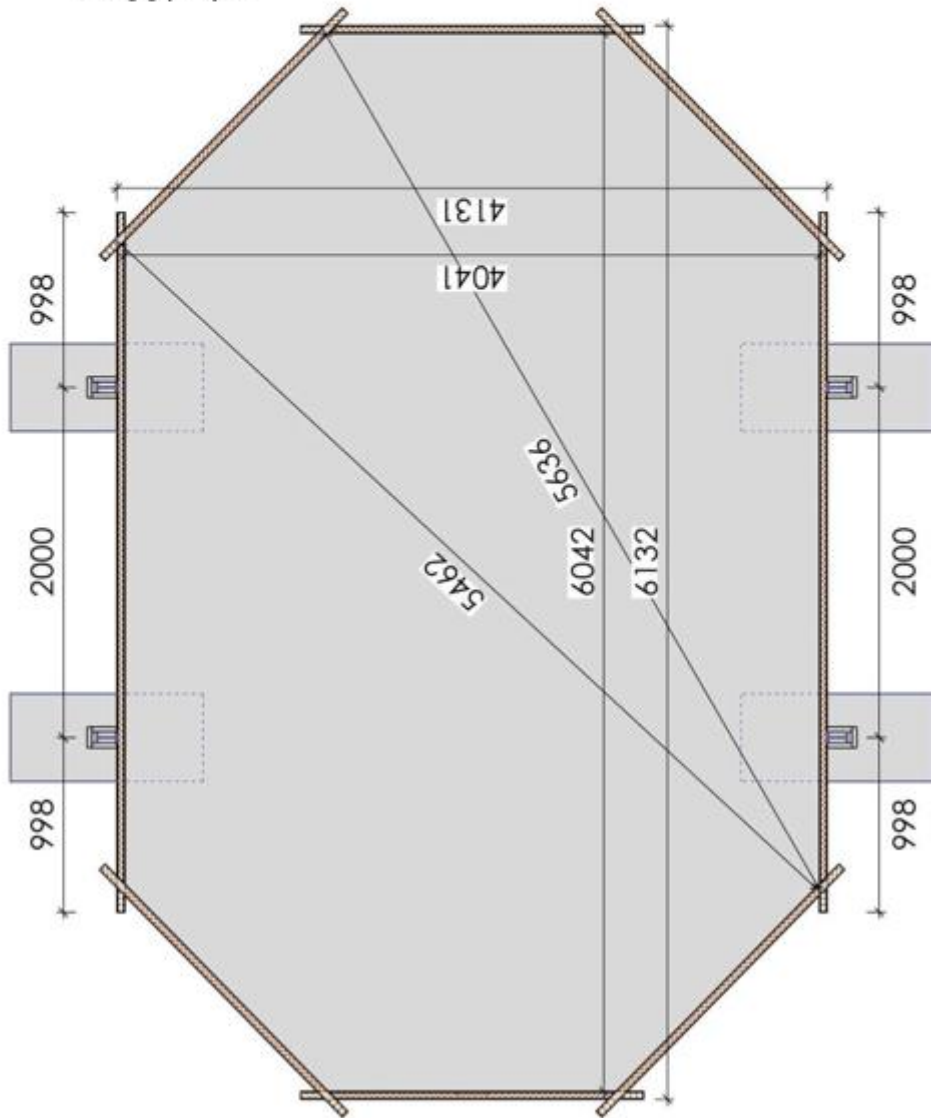
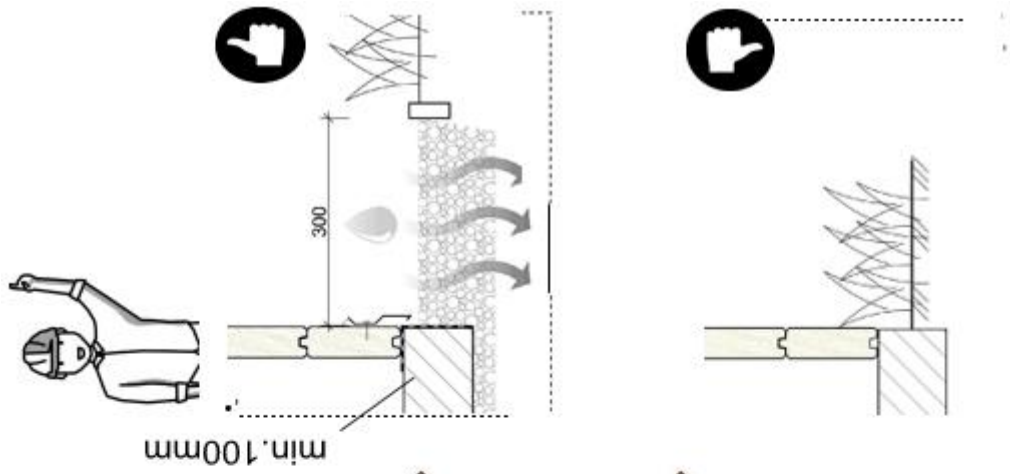

Pool in der Erde verbauen:

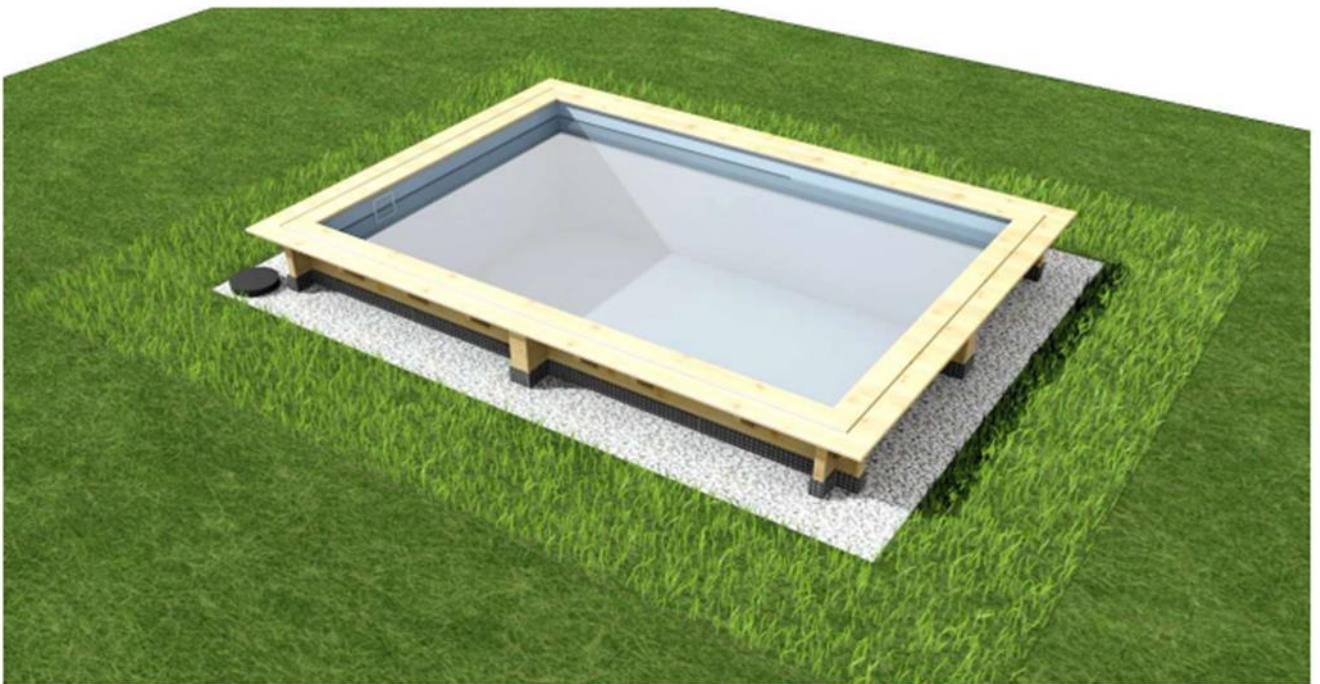
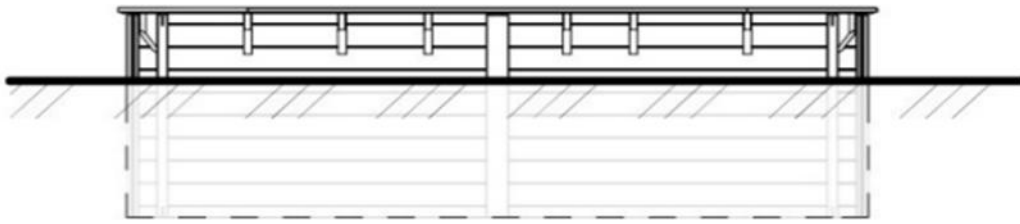

1

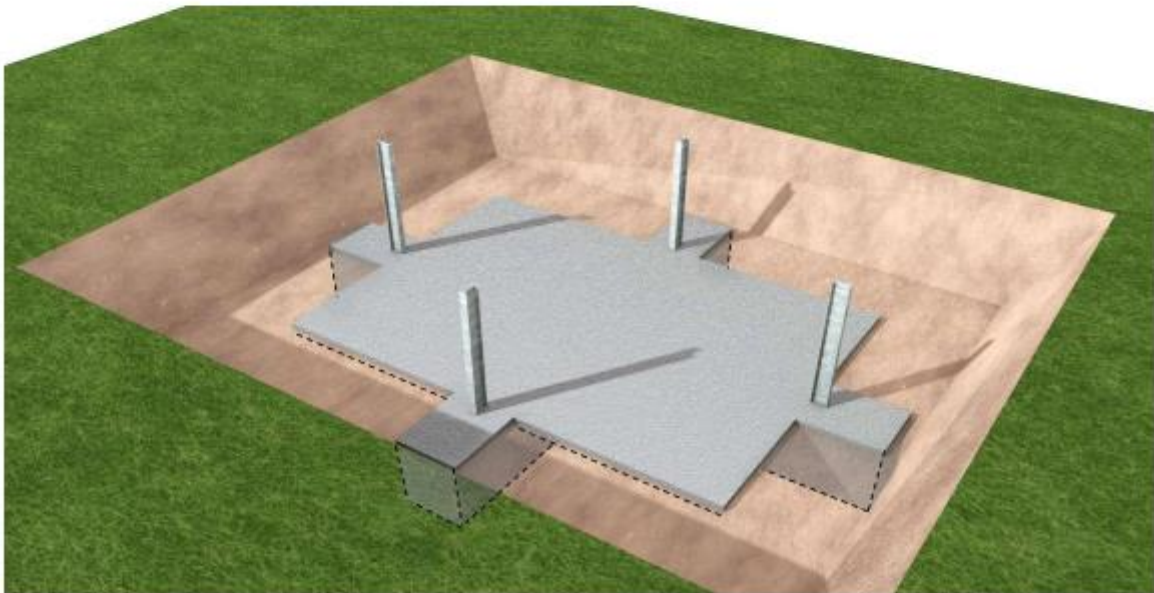
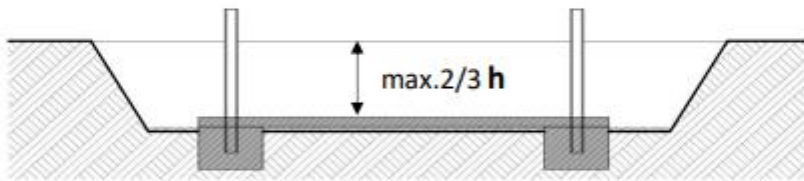
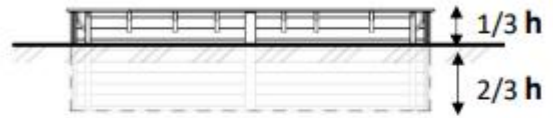
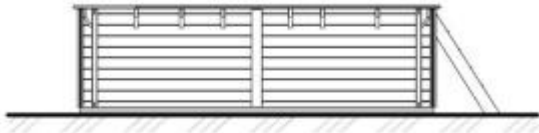
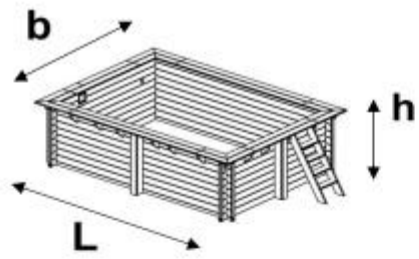

2

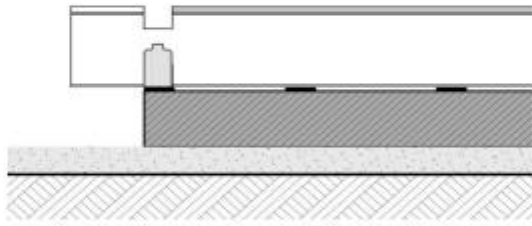
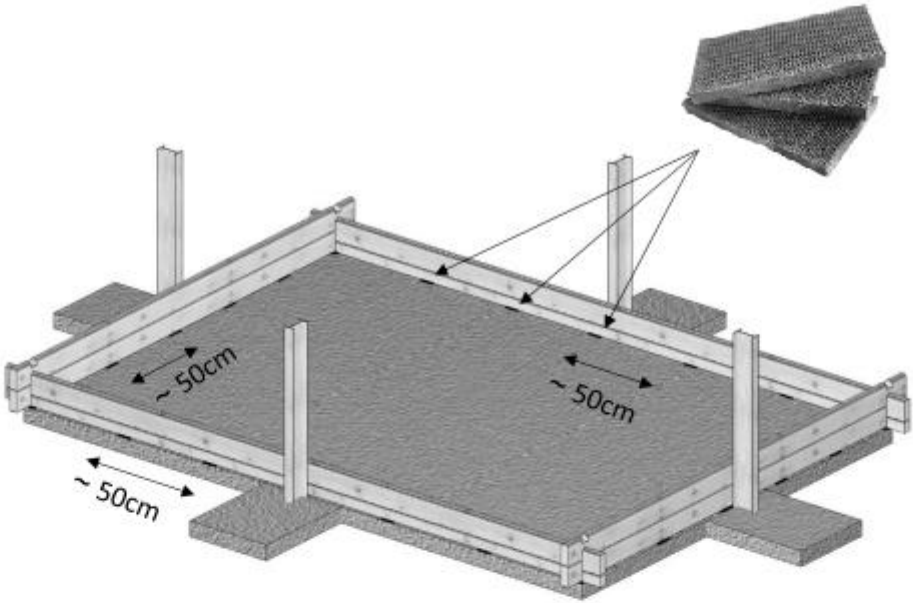

Um die Beckenwand von Schäden zu schützen, muss diese mit einer Noppenfolie eingehüllt werden.

3

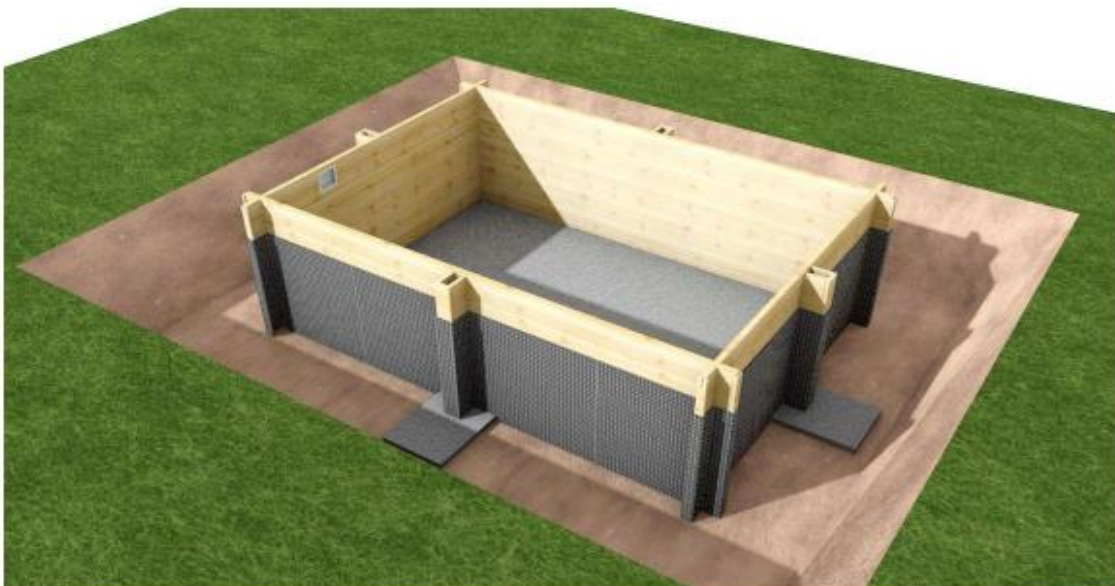
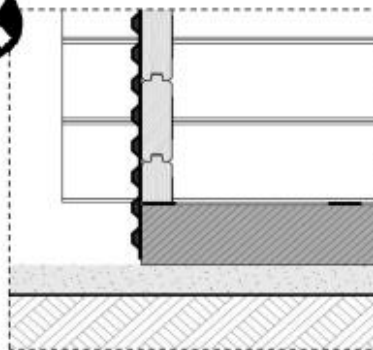
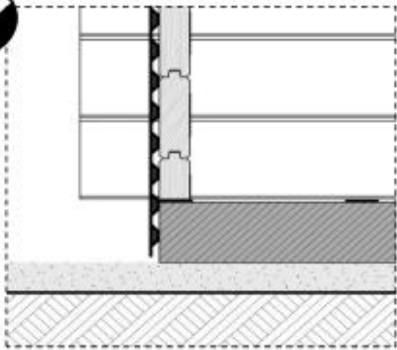
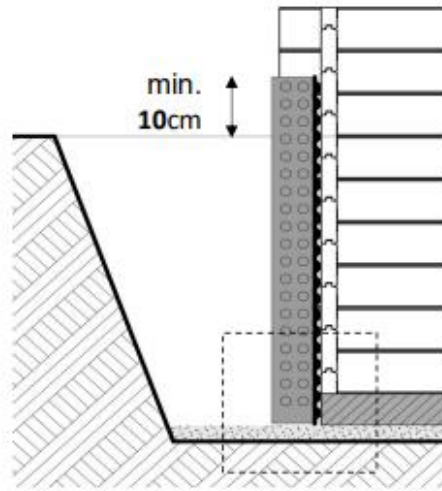

Verwenden Sie zur Entwässerung Drainagerohre mit einem Durchmesser von mindestens 10 cm.
Wenn der Boden Wasserundurchlässig ist, muss dieser durch groben Kies ersetzt werden.

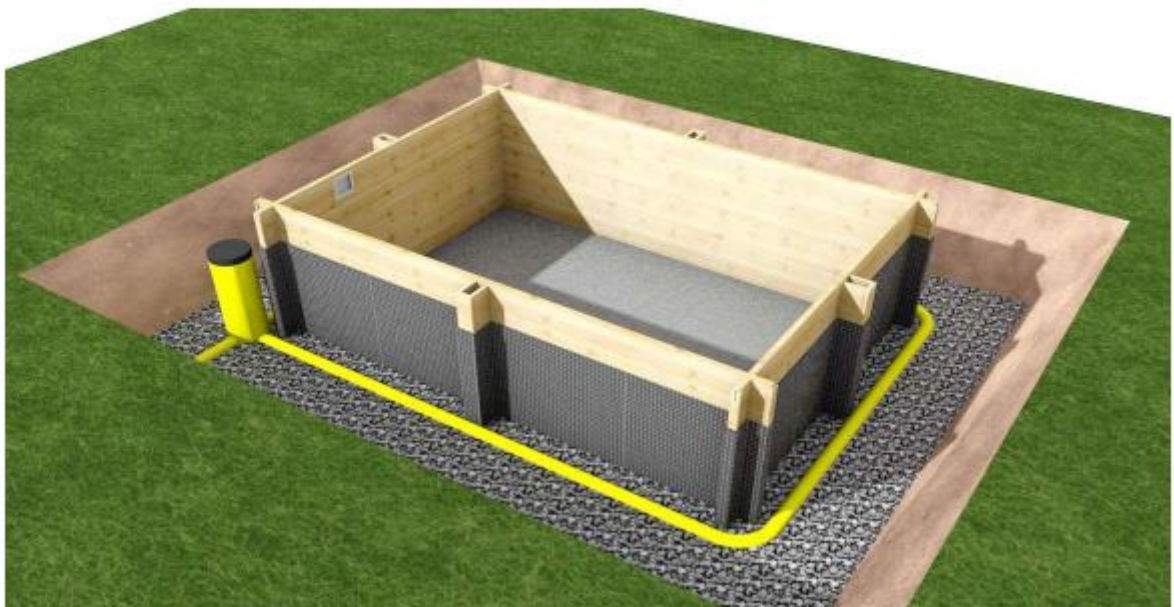
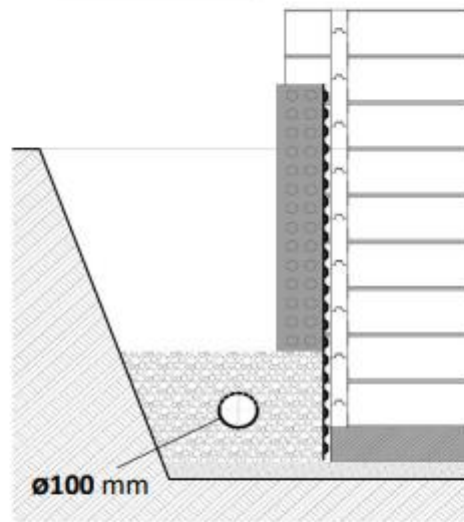
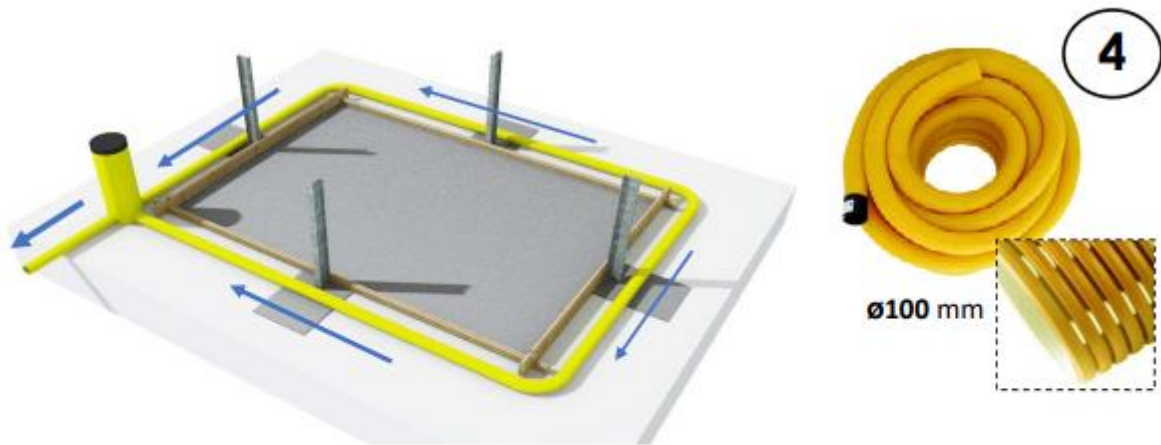

5

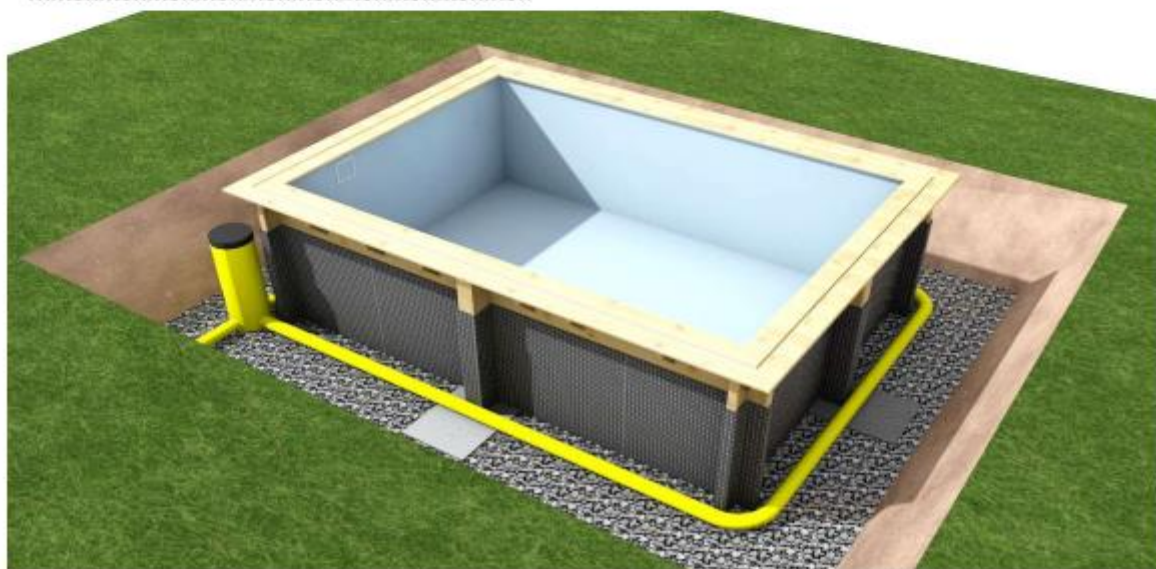
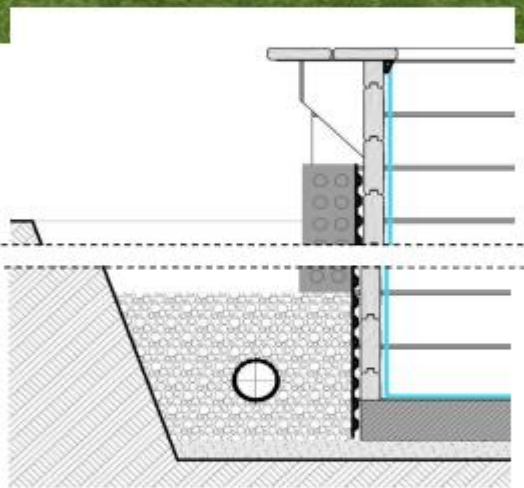
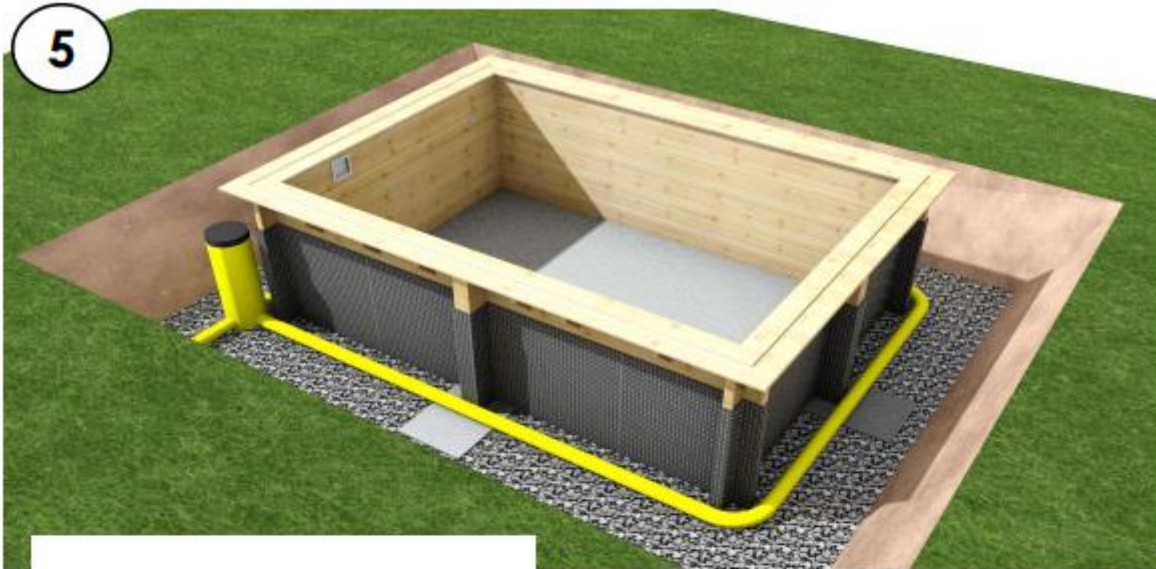

Die Grube, worin sich das Becken befindet, muss gleichmäßig mit dem Anstieg des Wasserspiegels befüllt werden.

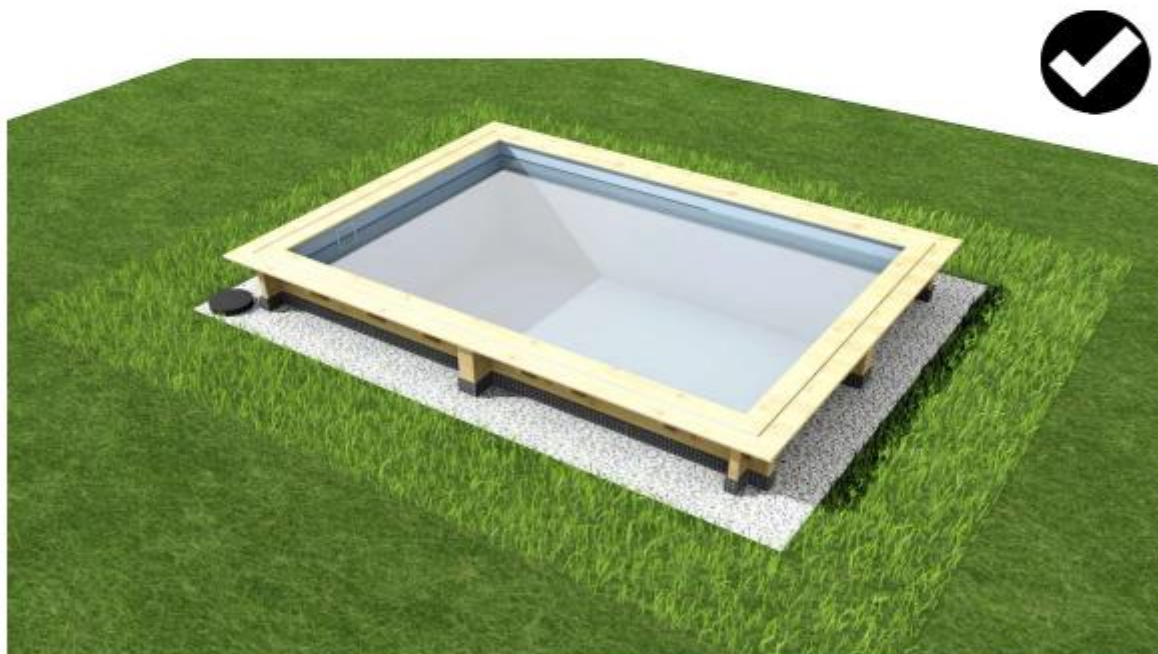
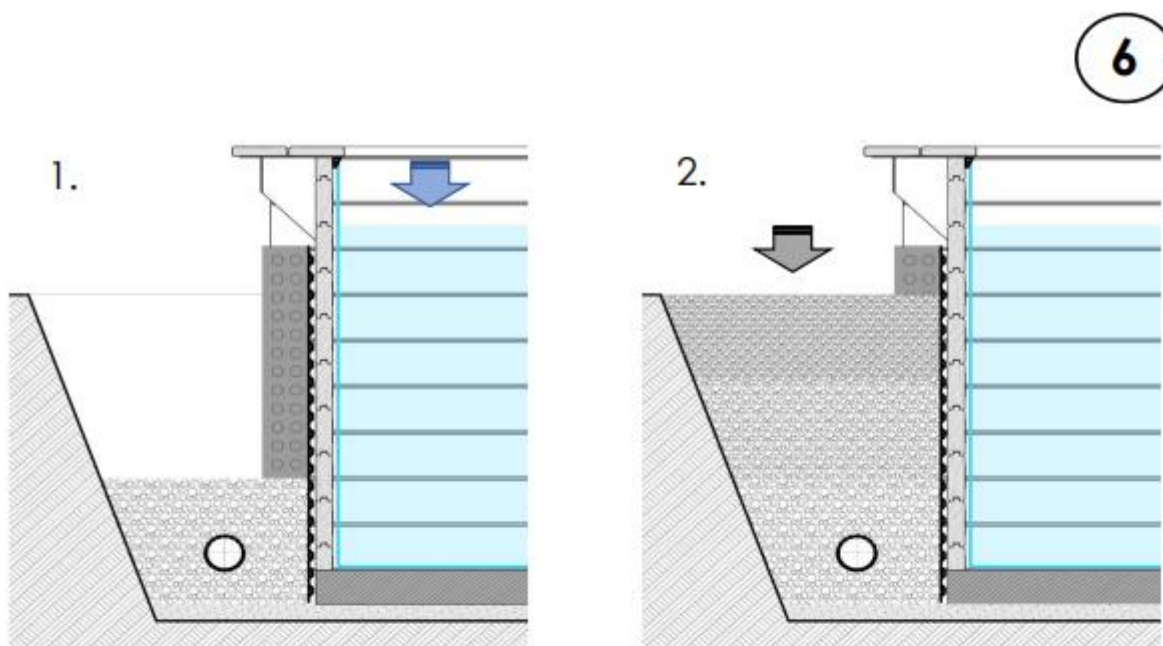

Beim Einwintern Ihres Holzpool's ist darauf zu achten das der Pool ca. bis zur Hälfte mit Wasser befüllt bleibt.

1

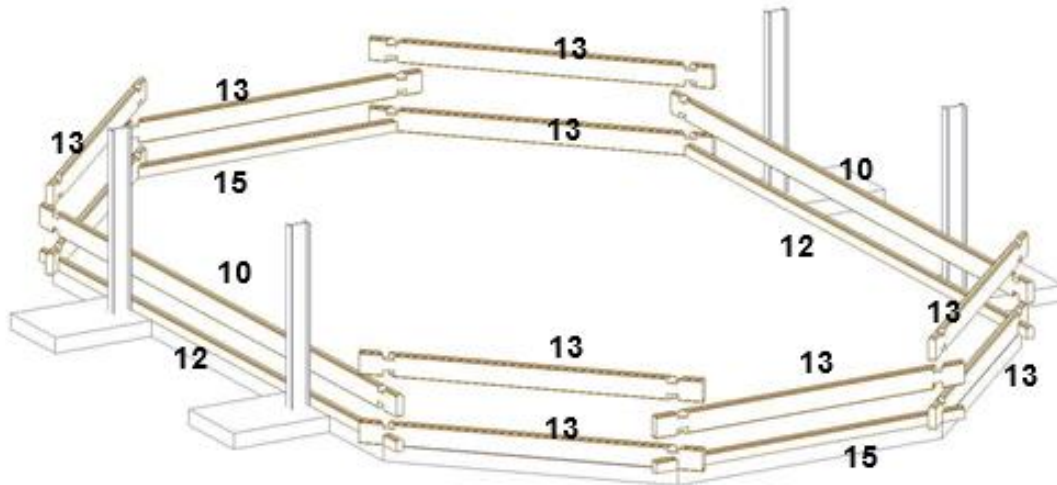
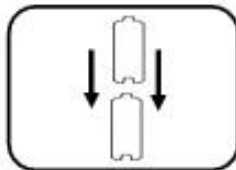
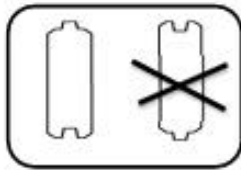

2

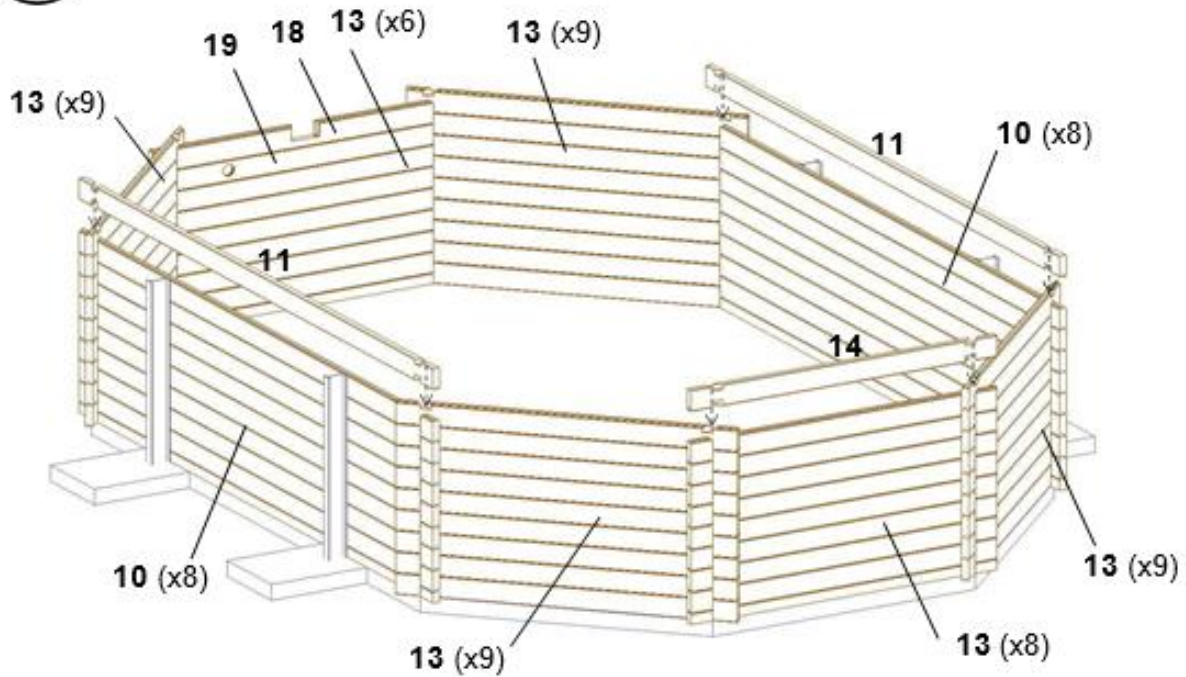

3

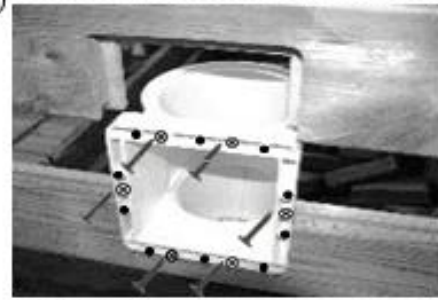
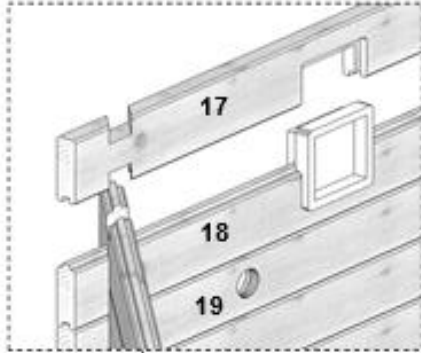

Ø4,0x40 (x6)



+ Ø4,0x40 (x16)

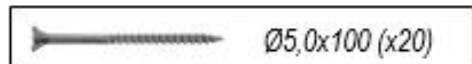
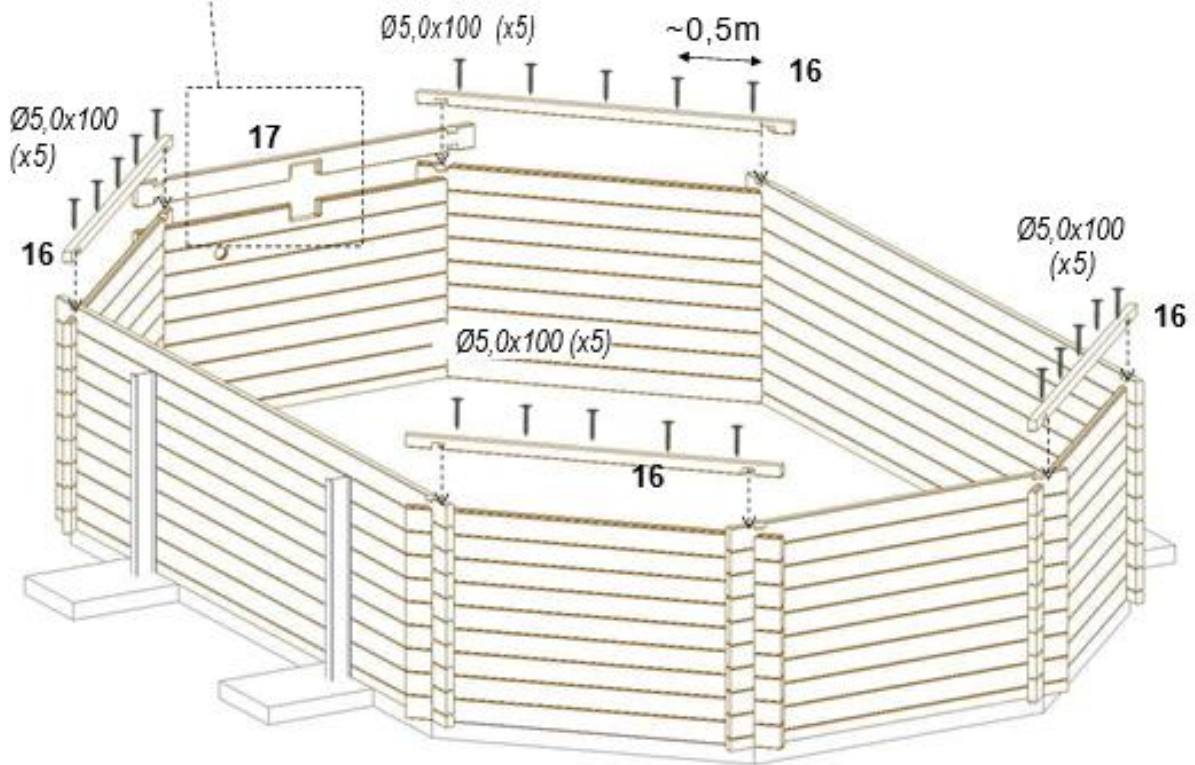

4

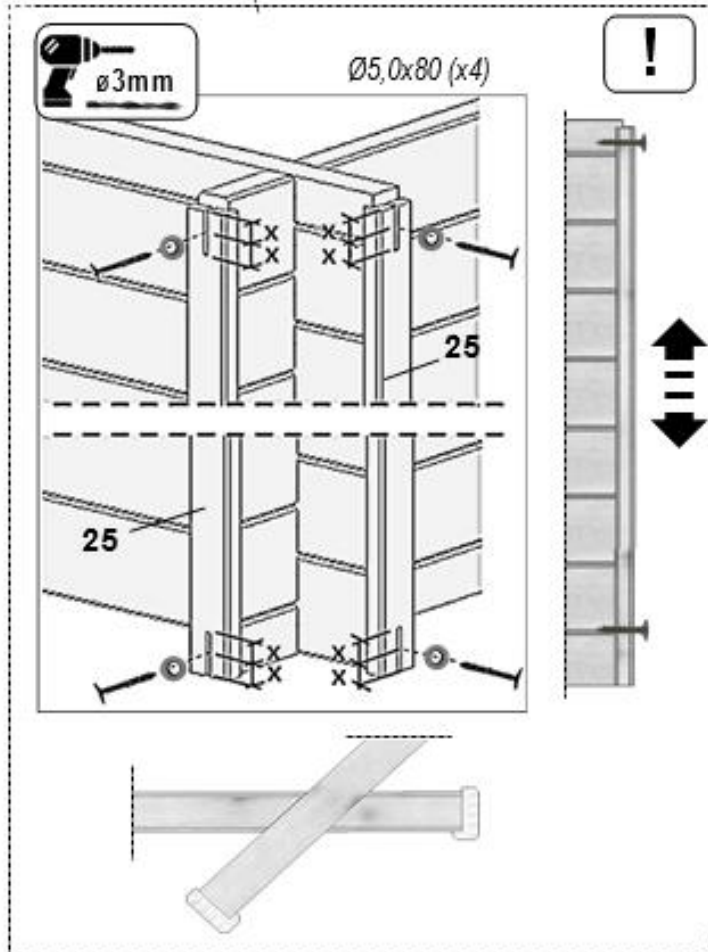
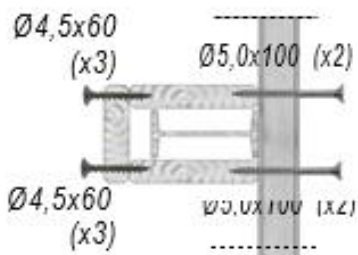
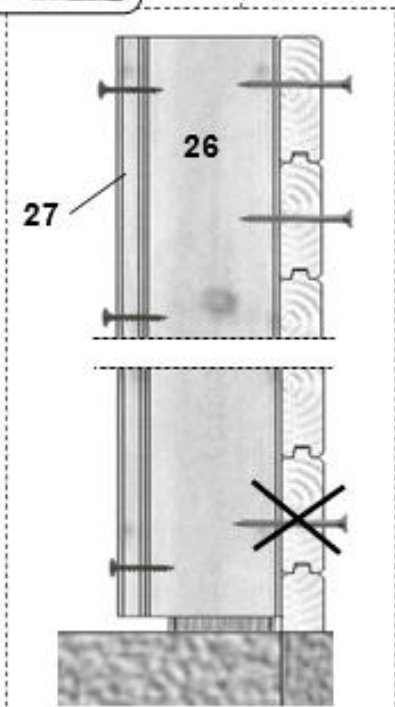
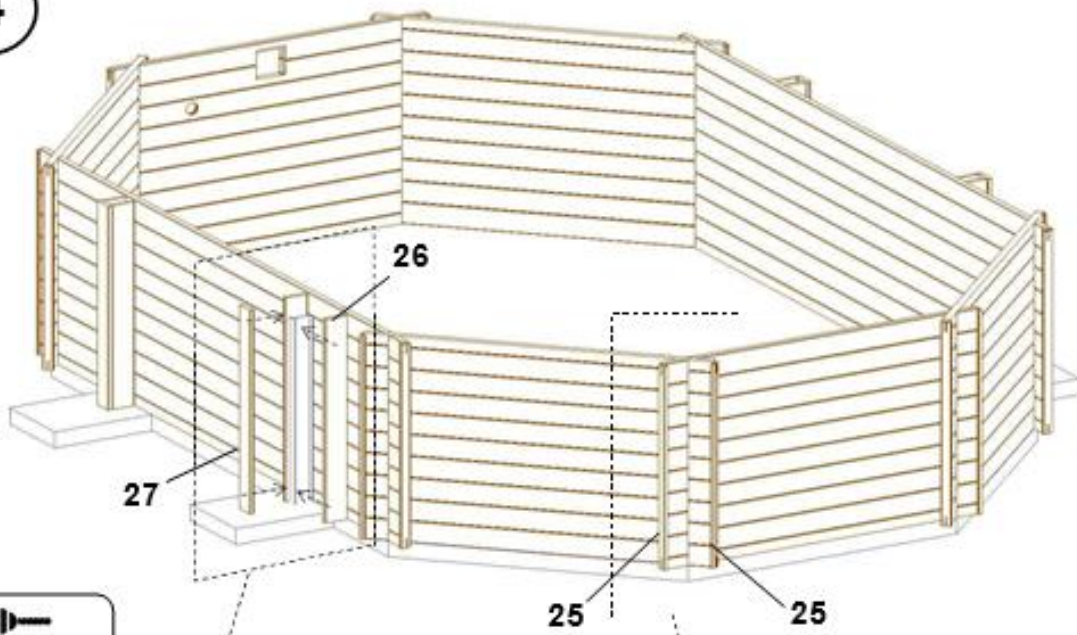

	Ø5,0x80	(x32)
	Ø4,5x60	(x24)
	Ø5,0x100	(x16)

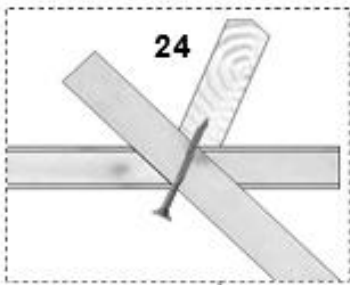

Ø5,0x100 (x2)

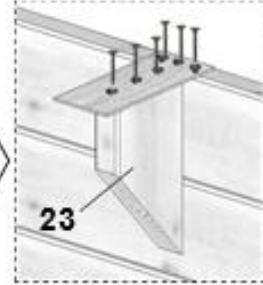
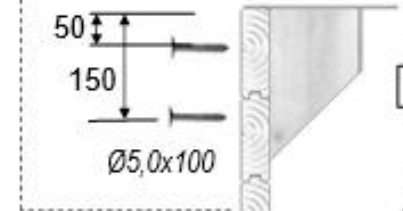

Ø3,5x25 (x6)

5

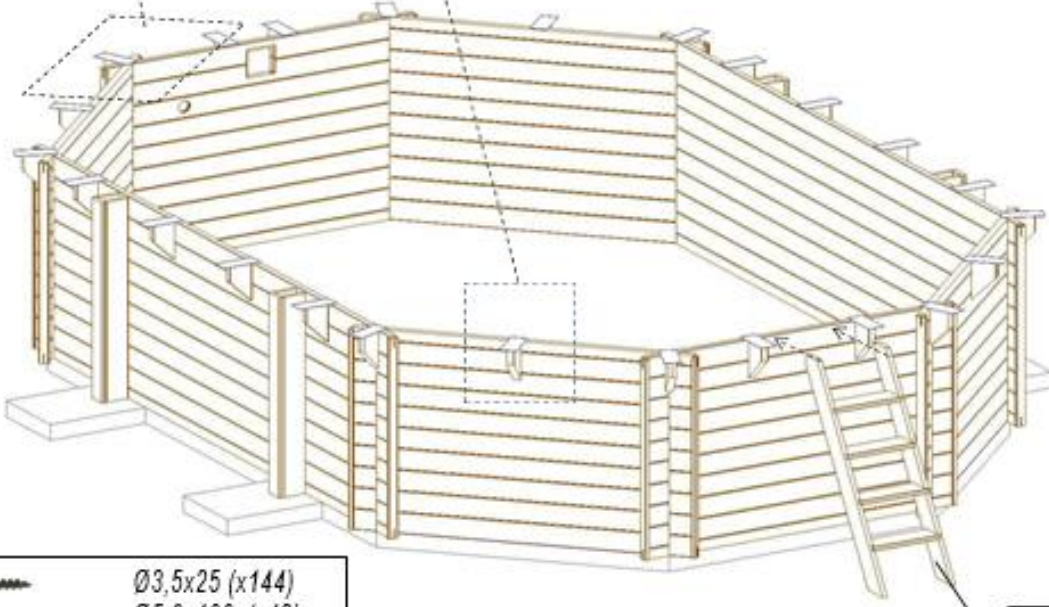

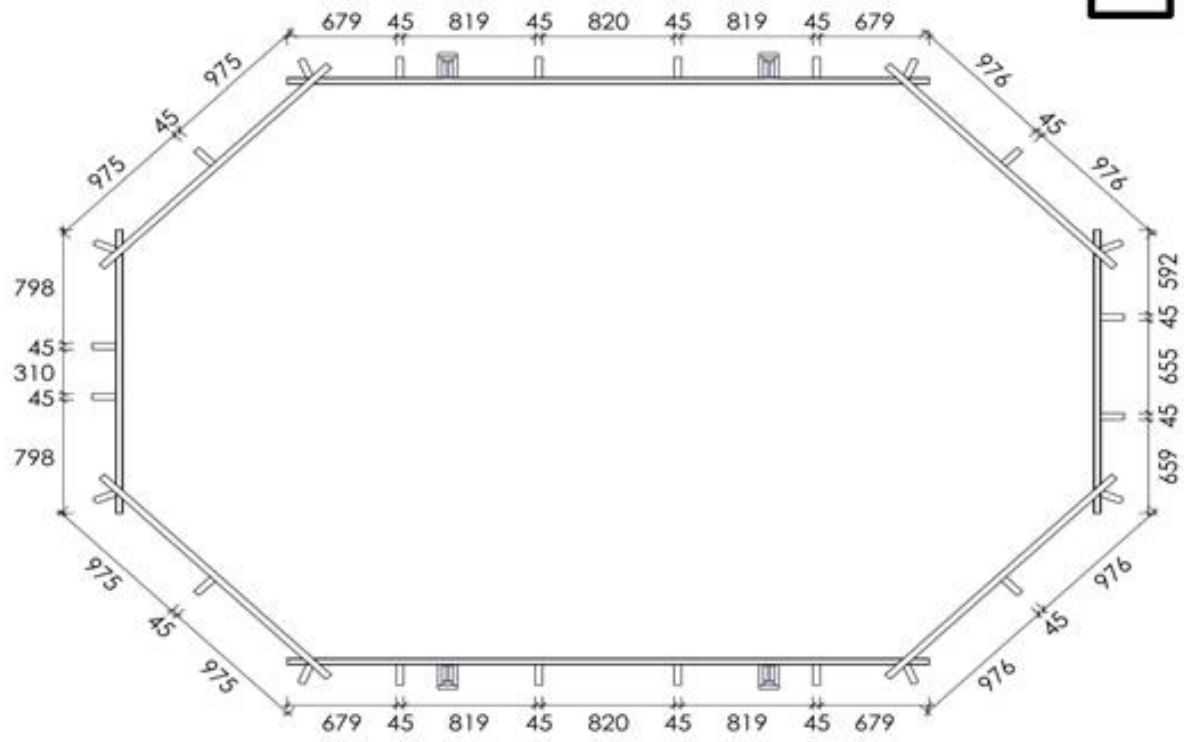
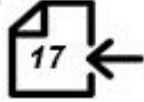

-  Ø3,5x25 (x144)
-  Ø5,0x100 (x48)



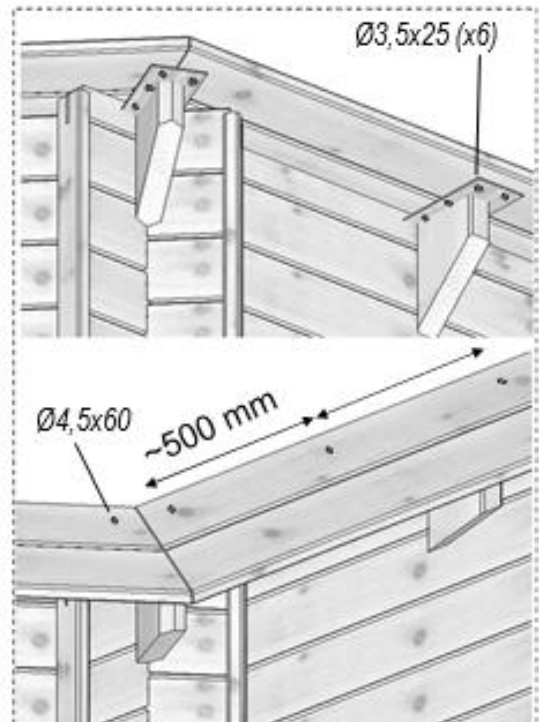
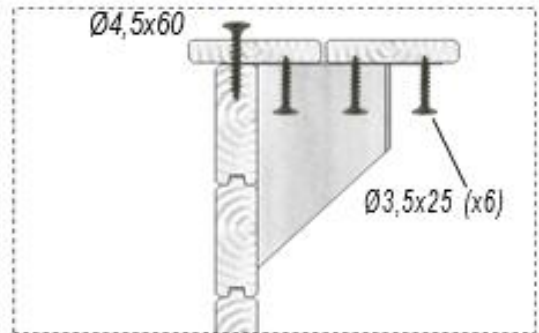
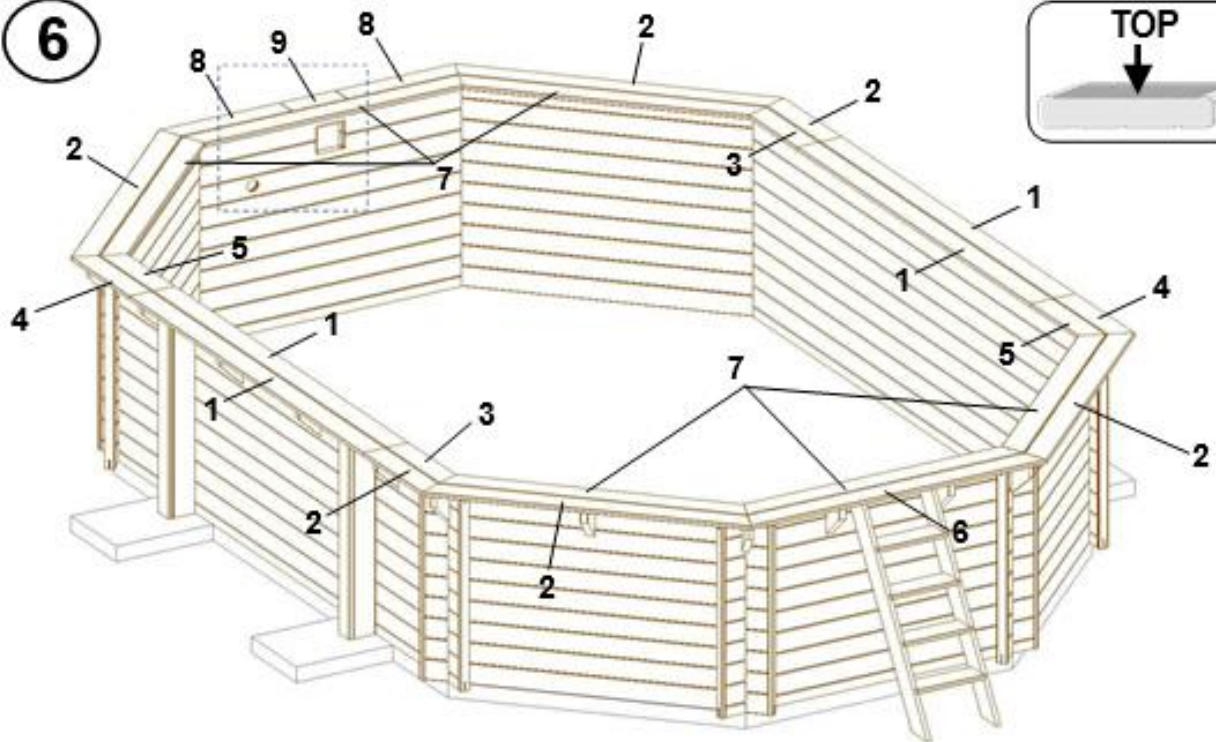

6

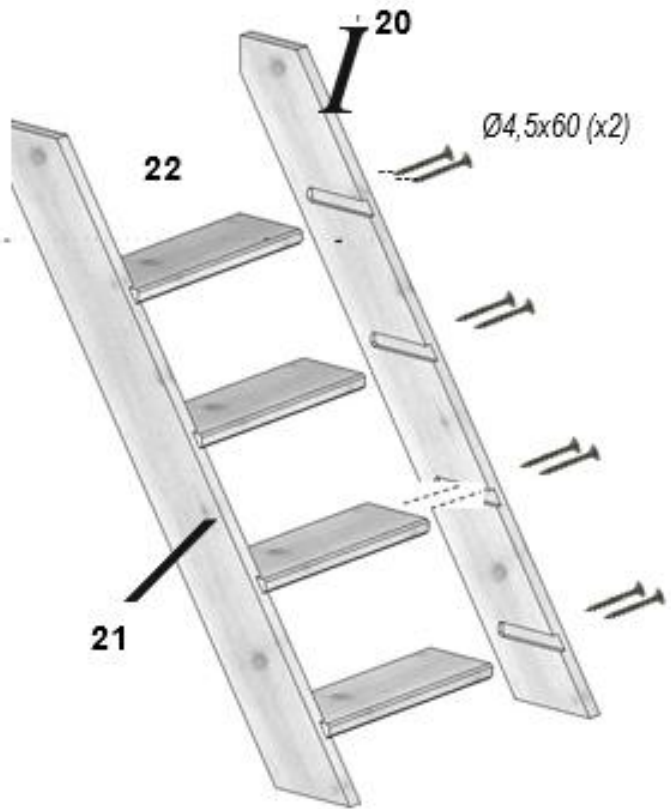
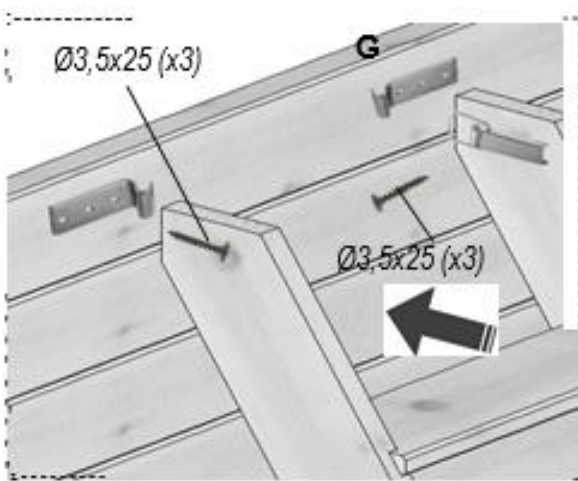

- | | |
|---|----------------|
|  | Ø3,0x25 (x12) |
|  | Ø3,5x25 (x144) |
|  | Ø4,5x60 (x44) |

7



	$\text{Ø}3,5 \times 25$ - x12
	$\text{Ø}4,5 \times 60$ - x16